

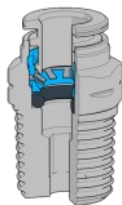

NICKEL PLATED BRASS PUSH-IN FITTINGS

CONSTRUCTION

- Body/Release Ring: Brass UNI EN 12164 CW614N - UNI EN 12165 CW617N Nickel Plated
- Release Ring: Brass UNI EN 12164 CW614N - UNI EN 12165 CW617N Nickel Plated
- Holding Ring: POM
- Gripping ring: Stainless Steel AISI 301
- Protection Ring: POM
- Seals: NBR



APPLICATIONS

- Recommended tubing: PA11, PA12, PA6, Polyethylene PE, Polyurethane PU (98 Shore A).
- Acceptable Tolerances on the tubing: +/- 0,07 mm up to Ø 3/8", +/- 0,1 mm Ø 1/2".
- Application fields: Pneumatic circuits.

RANGES

- Temperature Range: -4° to 176° F.
- Pressure Range: Max 290 PSI
- REACH / ROHS Compliant
- Silicone Free



Assembly Instructions

1. Cut tubing squarely—using a tube cutter.
2. Make sure all fittings involved in the assembly are clean of burrs and debris.
3. Insert tubing firmly into the release ring of the fitting until it bottoms out.
4. Check your connection is secure and leak free.
5. To release tubing, hold down the release ring firmly and pull the tube away from the fitting.





















NOTES

- Fittings are electrolytic nickel-plated.
- Non-stock items and special parts are available on a quotation basis.
- Configurations and dimensions are subject to change without notice.

⚠ WARNING: Products offered by Robo-Fit can expose you to chemicals such as lead, a chemical which is known to the State of California to cause cancer, birth defects, or other reproductive harm. For more information go to www.P65Warnings.ca.gov



<p>259PPNI Plug</p> 	<p>262PPNI Union</p> 	<p>262PPBHNI Bulkhead Union</p> 	<p>264PPNI Union Tee</p> 
<p>265PPNI 90° Union Elbow</p> 	<p>266PPNI Female Connector</p> 	<p>268PPNI Male Connector</p> 	<p>269PPNI 90° Male Elbow</p> 
<p>269PPSNI 90° Male Swivel Elbow</p> 	<p>270PPSNI 90° Female Swivel Elbow</p> 	<p>271PPSNI Male Swivel Run Tee</p> 	<p>272PPSNI Male Swivel Branch Tee</p> 
<p>277PPSNI Female Swivel Branch Tee</p> 	<p>279PPSNI 45° Male Swivel Elbow</p> 	<p>286PPBHNI Bulkhead Connector</p> 	<p>289PPNI Union Y</p> 
<p>2688PPNI Press-In Cartridge</p> 	<p>PPNIPIR Plug In Reducer</p> 	<p>PPNIPIE 90° Plug In Reducer</p> 	



259PPNI PLUG

PART NUMBER	O.D. TUBE	OAL
259PPNI-2	1/8"	.787
259PPNI-2.5	5/32"	.984
259PPNI-4	1/4"	.984
259PPNI-5	5/16"	1.181
259PPNI-6	3/8"	1.378
259PPNI-8	1/2"	1.575



264PPNI UNION TEE

PART NUMBER	O.D. TUBE	OAL
264PPNI-2	1/8"	.92
264PPNI-2.5	5/32"	1.378
264PPNI-4	1/4"	1.575
264PPNI-5	5/16"	1.654
264PPNI-6	3/8"	1.929
264PPNI-8	1/2"	2.126



262PPNI UNION

PART NUMBER	O.D. TUBE	OAL
262PPNI-2	1/8"	.827
262PPNI-2.5	5/32"	1.11
262PPNI-4	1/4"	1.339
262PPNI-5	5/16"	1.354
262PPNI-6X4	3/8" x 1/4"	1.457
262PPNI-6	3/8"	1.74
262PPNI-8X6	1/2" x 3/8"	1.594
262PPNI-8	1/2"	1.606



265PPNI 90° UNION ELBOW

PART NUMBER	O.D. TUBE	CNT Line to Tube
265PPNI-2	1/8"	.461
265PPNI-2.5	5/32"	.689
265PPNI-4	1/4"	.807
265PPNI-5	5/16"	.886
265PPNI-6	3/8"	.984
265PPNI-8	1/2"	1.063



262PPBHNI BULKHEAD UNION

PART NUMBER	O.D. TUBE	OAL	HEX
262PPBHNI-2	1/8"	.827	.551
262PPBHNI-2.5	5/32"	1.10	.63
262PPBHNI-4	1/4"	1.34	.709
262PPBHNI-5	5/16"	1.34	.787
262PPBHNI-6	3/8"	1.53	.866
262PPBHNI-8	1/2"	1.61	1.024



266PPNI FEMALE CONNECTOR

PART NUMBER	O.D. TUBE	FPT	OAL
266PPNI-2.5A	5/32"	1/8"	.984
266PPNI-4A	1/4"	1/8"	1.06
266PPNI-4B	1/4"	1/4"	1.24
266PPNI-5A	5/16"	1/8"	1.06
266PPNI-5B	5/16"	1/4"	1.24
266PPNI-6B	3/8"	1/4"	1.34
266PPNI-6C	3/8"	3/8"	1.34





268PPNI MALE CONNECTOR

PART NUMBER	O.D. TUBE	MPT	OAL	HEX
268PPNI-2X0	1/8"	10-32 UNF	.657	3/32"
268PPNI-2A	1/8"	1/8"	.728	3/32"
268PPNI-2.5X0	5/32"	10-32 UNF	.787	3/32"
268PPNI-2.5A	5/32"	1/8"	.768	7/16"
268PPNI-2.5B	5/32"	1/4"	.945	9/16"
268PPNI-4X0	1/4"	10-32 UNF	.925	3/32"
268PPNI-4A	1/4"	1/8"	.866	1/2"
268PPNI-4B	1/4"	1/4"	.965	9/16"
268PPNI-4C	1/4"	3/8"	1.00	11/16"
268PPNI-5A	5/16"	1/8"	1.04	9/16"
268PPNI-5B	5/16"	1/4"	1.00	9/16"
268PPNI-5C	5/16"	3/8"	.984	11/16"
268PPNI-6A	3/8"	1/8"	1.12	11/16"
268PPNI-6B	3/8"	1/4"	1.26	11/16"
268PPNI-6C	3/8"	3/8"	1.00	11/16"
268PPNI-6D	3/8"	1/2"	1.20	7/8"
268PPNI-8B	1/2"	1/4"	1.36	13/16"
268PPNI-8C	1/2"	3/8"	1.16	13/16"
268PPNI-8D	1/2"	1/2"	1.20	7/8"



269PPSNI 90° MALE SWIVEL ELBOW

PART NUMBER	O.D. TUBE	MPT	HEX
269PPSNI-2X0	1/8"	10-32 UNF	3/8"
269PPSNI-2A	1/8"	1/8"	7/16"
269PPSNI-2.5X0	5/32"	10-32 UNF	3/8"
269PPSNI-2.5A	5/32"	1/8"	7/16"
269PPSNI-2.5B	5/32"	1/4"	9/16"
269PPSNI-4A	1/4"	1/8"	1/2"
269PPSNI-4B	1/4"	1/4"	9/16"
269PPSNI-4C	1/4"	3/8"	11/16"
269PPSNI-5A	5/16"	1/8"	1/2"
269PPSNI-5B	5/16"	1/4"	9/16"
269PPSNI-5C	5/16"	3/8"	11/16"
269PPSNI-6A	3/8"	1/8"	11/16"
269PPSNI-6B	3/8"	1/4"	11/16"
269PPSNI-6C	3/8"	3/8"	11/16"
269PPSNI-6D	3/8"	1/2"	7/8"
269PPSNI-8B	1/2"	1/4"	13/16"
269PPSNI-8C	1/2"	3/8"	13/16"
269PPSNI-8D	1/2"	1/2"	7/8"



269PPNI 90° MALE ELBOW

PART NUMBER	O.D. TUBE	MPT	FLATS
269PPNI-2.5A	5/32"	1/8"	.394
269PPNI-4A	1/4"	1/8"	.394
269PPNI-4B	1/4"	1/4"	.394
269PPNI-5A	5/16"	1/8"	.472
269PPNI-5B	5/16"	1/4"	.472
269PPNI-6B	3/8"	1/4"	.551
269PPNI-6C	3/8"	3/8"	.551



270PPSNI 90° FEMALE SWIVEL ELBOW

PART NUMBER	O.D. TUBE	FPT	HEX
270PPSNI-2.5A	5/32"	1/8"	9/16"
270PPSNI-4A	1/4"	1/8"	9/16"
270PPSNI-4B	1/4"	1/4"	11/16"
270PPSNI-5A	5/16"	1/8"	9/16"
270PPSNI-5B	5/16"	1/4"	11/16"
270PPSNI-6B	3/8"	1/4"	11/16"
270PPSNI-6C	3/8"	3/8"	13/16"





271PPSNI MALE SWIVEL RUN TEE

PART NUMBER	O.D. TUBE	MPT	HEX
271PPSNI-2A	1/8"	1/8"	1/2"
271PPSNI-2.5A	5/32"	1/8"	1/2"
271PPSNI-2.5B	5/32"	1/4"	9/16"
271PPSNI-4A	1/4"	1/8"	1/2"
271PPSNI-4B	1/4"	1/4"	9/16"
271PPSNI-5A	5/16"	1/8"	1/2"
271PPSNI-5B	5/16"	1/4"	9/16"
271PPSNI-6B	3/8"	1/4"	11/16"
271PPSNI-6C	3/8"	3/8"	11/16"
271PPSNI-8C	1/2"	3/8"	13/16"
271PPSNI-8D	1/2"	1/2"	7/8"



277PPSNI FEMALE SWIVEL BRANCH TEE

PART NUMBER	O.D. TUBE	FPT
277PPSNI-4B	1/4"	1/4"
277PPSNI-6B	3/8"	1/4"
277PPSNI-6C	3/8"	3/8"
277PPSNI-8C	1/2"	3/8"
277PPSNI-8D	1/2"	1/2"



272PPSNI MALE SWIVEL BRANCH TEE

PART NUMBER	O.D. TUBE	MPT	HEX
272PPSNI-2A	1/8"	1/8"	1/2"
272PPSNI-2.5A	5/32"	1/8"	1/2"
272PPSNI-2.5B	5/32"	1/4"	9/16"
272PPSNI-4A	1/4"	1/8"	1/2"
272PPSNI-4B	1/4"	1/4"	9/16"
272PPSNI-5A	5/16"	1/8"	1/2"
272PPSNI-5B	5/16"	1/4"	9/16"
272PPSNI-6B	3/8"	1/4"	11/16"
272PPSNI-6C	3/8"	3/8"	11/16"
272PPSNI-8C	1/2"	3/8"	13/16"
272PPSNI-8D	1/2"	1/2"	7/8"



279PPSNI 45° MALE ELBOW

PART NUMBER	O.D. TUBE	MPT
279PPSNI-4A	1/4"	1/8"
279PPSNI-4B	1/4"	1/4"
279PPSNI-6B	3/8"	1/4"
279PPSNI-6C	3/8"	3/8"
279PPSNI-6D	3/8"	1/2"
279PPSNI-8C	1/2"	3/8"
279PPSNI-8D	1/2"	1/2"



286PPBHNI BULKHEAD CONNECTOR

PART NUMBER	O.D. TUBE	FPT
286PPBHNI-2.5B	5/32"	1/4"
286PPBHNI-4A	1/4"	1/8"
286PPBHNI-4B	1/4"	1/4"
286PPBHNI-6B	3/8"	1/4"
286PPBHNI-6C	3/8"	3/8"
286PPBHNI-6D	3/8"	1/2"
286PPBHNI-8C	1/2"	3/8"
286PPBHNI-8D	1/2"	1/2"



289PPNI UNION Y

PART NUMBER	O.D. TUBE
289PPNI-2	1/8" (X3)
289PPNI-2.5	5/32" (X3)
289PPNI-4	1/4" (X3)
289PPNI-5	5/16" (X3)
289PPNI-6	3/8" (X3)



PPNIPIR PLUG IN REDUCER

PART NUMBER	O.D. TUBE	STANDPIPE
PPNIPIR-2-2.5	1/8"	5/32"
PPNIPIR-2.5-4	5/32"	1/4"
PPNIPIR-4-5	1/4"	5/16"
PPNIPIR-4-6	1/4"	3/8"
PPNIPIR-4-8	1/4"	1/2"
PPNIPIR-5-6	5/16"	3/8"
PPNIPIR-6-8	3/8"	1/2"



2688PPNI PRESS-IN CARTRIDGE

PART NUMBER	O.D. TUBE
2688PPNI-2.5	5/32"
2688PPNI-4	1/4"
2688PPNI-5	5/16"
2688PPNI-6	3/8"



PPNIPIE 90° PLUG IN REDUCER

PART NUMBER	O.D. TUBE	STANDPIPE
PPNIPIE-2.5	5/32"	5/32"
PPNIPIE-4	1/4"	1/4"
PPNIPIE-6	3/8"	3/8"
PPNIPIE-8	1/2"	1/2"



CARTRIDGE SEAT DRILLING PLAN

Tube OD	D ₁	D ₂	D ₃	D ₄	L ₁	L ₂
5/32	.374	.362	.118	.339	.472	.126
1/4	.480	.469	.217	.445	.551	.157
5/16	.547	.535	.276	.512	.571	.157
3/8	.610	.598	.335	.575	.630	.157

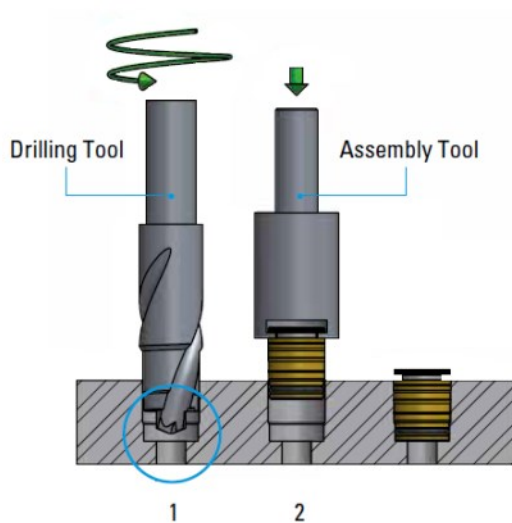
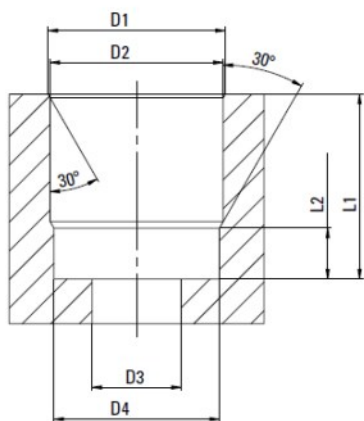

Corrosion Resistant
Fast Installation
Consistently Reliable